

Mini_USB

TDS Display Board

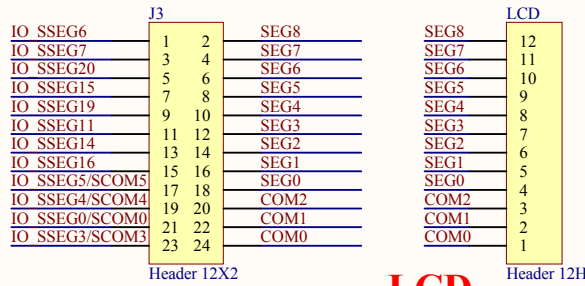

LCD

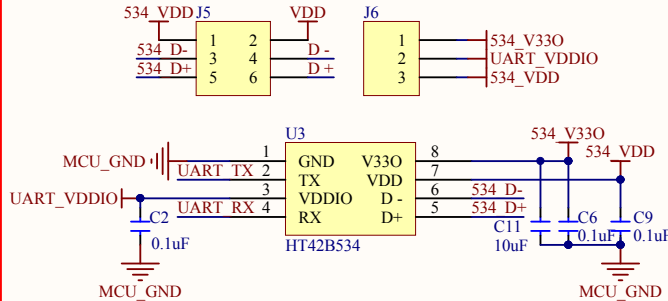
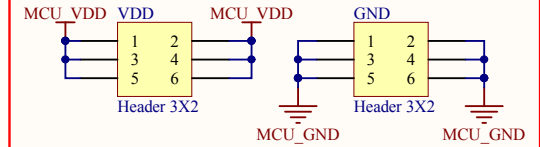

USB TO UART



connect to TDS Module

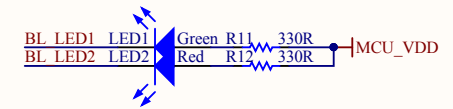

LED

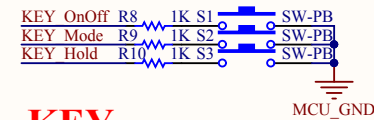
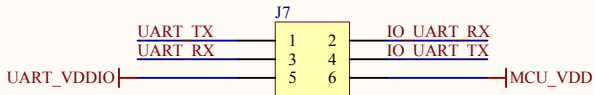

KEY

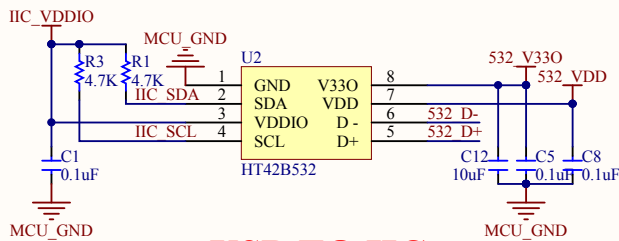

USB TO IIC

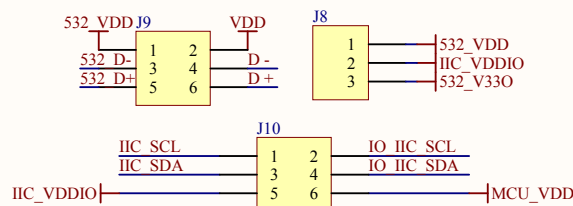

ICP

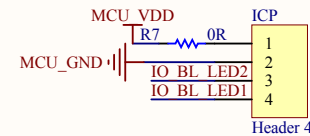

Title		
Size	Number	Revision
A4		
Date:	2019/7/2	Sheet of
File:	C:\Users\TDS\Workshop Bottom V1.0	Sheet No. By: