

BMCOM

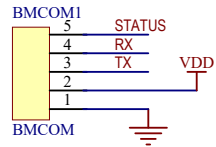

Power Circuit

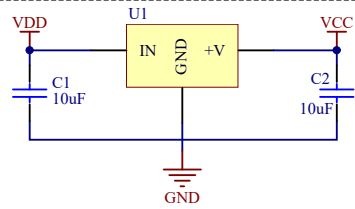

LDO Circuit

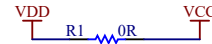

0Ω Circuit

LDO Circuit	0Ω Circuit
NC	V

Level Shift

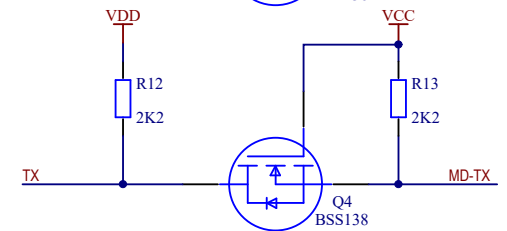
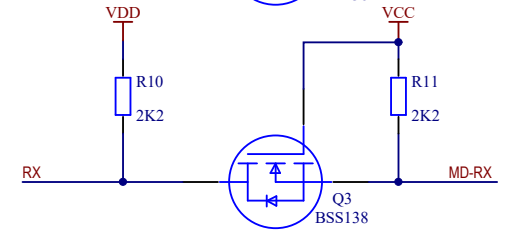
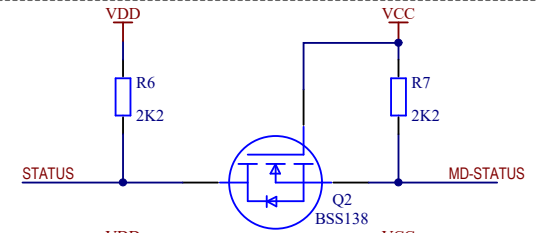

Level Shift Circuit



0Ω Circuit

0Ω Circuit	Level Shift Circuit
V	NC

LED Indicator

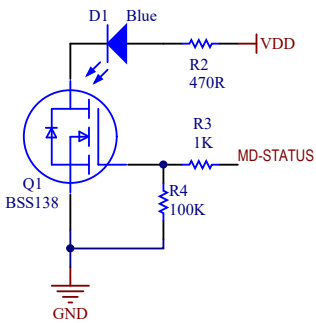

Smoke Detector Digital Sensor

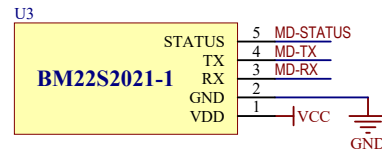

Reserved Interface(NC)

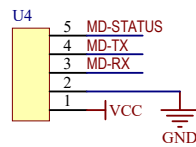
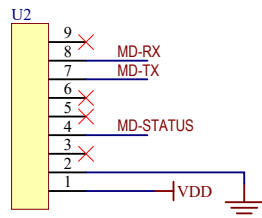

Title: BMA26M202
 Design by: BESTMOUDLES TEAM
 Data: 2023/8/15
 Rev: V1.2

